

PRO28

Heavy Duty 28 mm Modular Fixturing System

2020
Catalog



THE ONLY MODULAR HEAVY DUTY WELDING TABLE

The NEW PRO28 is the only *Modular* Heavy Duty Welding Table with positionable, self-locating, reversible Table Plates for unlimited possibilities in Heavy Duty Fixturing for Welding and Fabrication. Accurately locate, position and clamp stock for higher quality welding.

Table Plates are made from tough P20 low alloy tool steel and ground for flatness.

QPQ Nitriding Treatment provides corrosion and weld spatter resistance for superior performance and wear with HV750 case hardness.

Patented, self-locating Table Plates can be repositioned, then easily realigned to the original position. Reposition the table plates as needed to increase the width of the table for oversized or complex fixtures.



Each Heavy Duty Table leg supports 4,400 lb [2,000 kg].

2X Life! PRO28 Table Plates can be reversed to provide a new work surface.

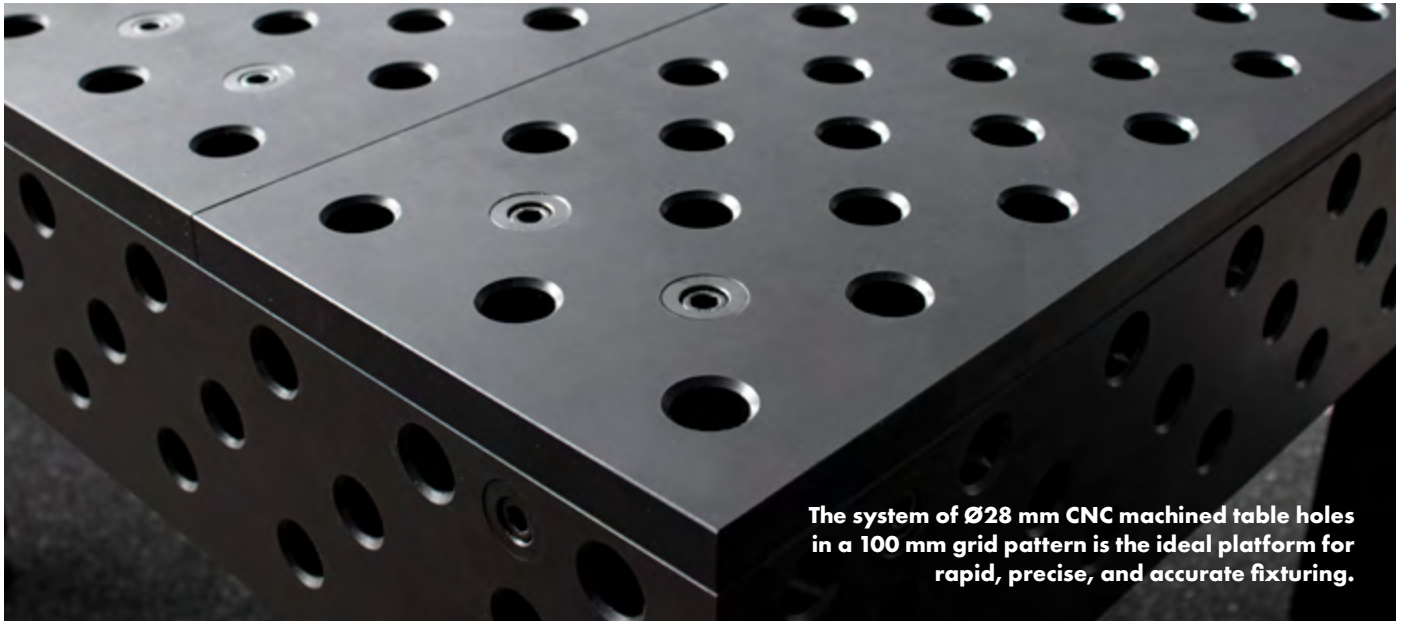

BuildPro® Engineers developed the PRO28 line by customer demand for an affordable, heavy duty, Welding Table. The five-face PRO28 Table is the optimal solution for precision vertical and horizontal fixturing to expand your capabilities in welding and fabrication.

Each plate is made from a low alloy tool steel that's tough enough for use in the mold making industry. After surface grinding and machining, each plate is further enhanced with a QPQ nitriding process that improves hardness, corrosion resistance, and resistance to weld spatter.

Plates on the table can be repositioned, or removed as applications dictate; a patented plate locating system means the spacing of the holes are always within tolerance without the need for special re-calibration.

The unique and versatile PRO28 tables are complemented by a complete range of modular fixtures and clamping accessories.

Visit our website to see the latest additions to the PRO28 product line and access technical details such as CAD drawings.

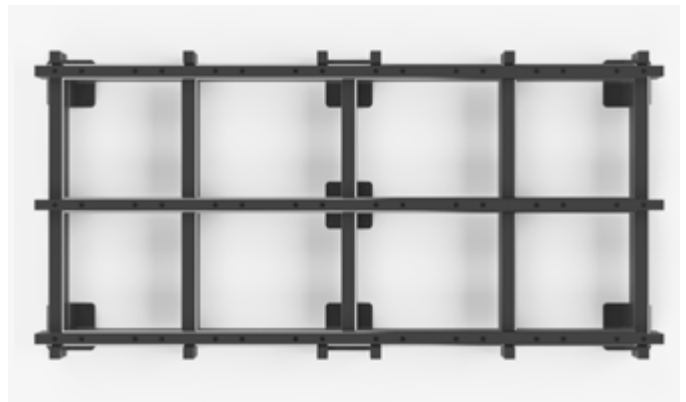

PRO28 tables combine the rigidity and accuracy of a welded and machined frame with the flatness of precision ground, CNC machined plates.

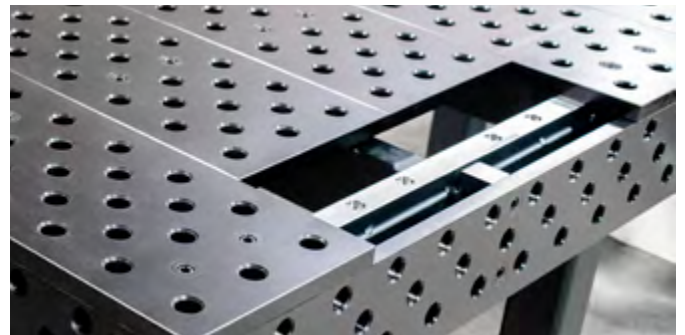

The patented Locating Bushing design allows you to easily remove, re-position, re-align, and reverse the table plates. Table Plates can be positioned to create the custom work surface configuration required for each unique fixturing application.

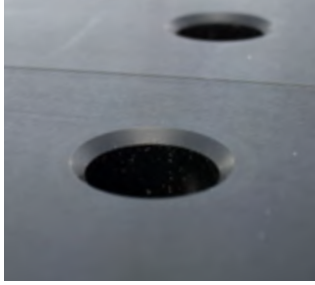

SYSTEM BOREHOLE

Hole Diameter: $28 + .20/-0$ mm

Hole Spacing: 100 ± 0.05 mm

Large chamfer on top for easy insertion. Chamfer on underside as well to maximize bolt clamping force.

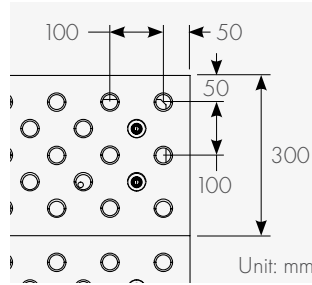

TABLE SURFACE

Table Flatness:
 ± 0.064 mm per 600×600 mm area
(± 0.0025 " per $24" \times 24"$ area)

Material: P20

Surface Hardness: HV750

Base Material Hardness:
HV 260-290

Borehole spacing 100 mm with additional 100 mm grid offset by 50 mm in the x and y axis, aka diagonal grid.



PRO28 tables feature 6 legs compared to competitors' 4 legs on 2.4 x 1.2 and 2.1 x 1.0 table sizes for greater rigidity and flatness



MATERIAL THICKNESS

Plate Thickness: 25 ± 0.06 mm

Tabletop Finish: Nitrided (Heat-Treated)

Coefficient of Friction: 0.37

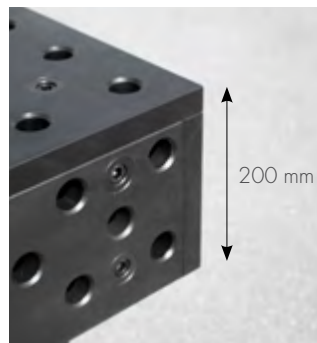
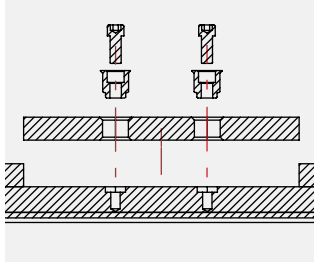

TABLE SIDE PANEL

Material: Q345B

Hardness: HV550

200 mm high



**PATENTED SELF-LOCATING
PLATE SYSTEM FOR TOP
AND SIDE PLATES**

Locating features in the table frame and plate combine with our locator bushings for self alignment.

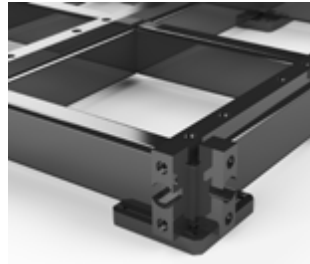

**PLATE MOUNTING DETAIL
FOR SIDE PLATES**

Side Plates also use self locating bushing system.

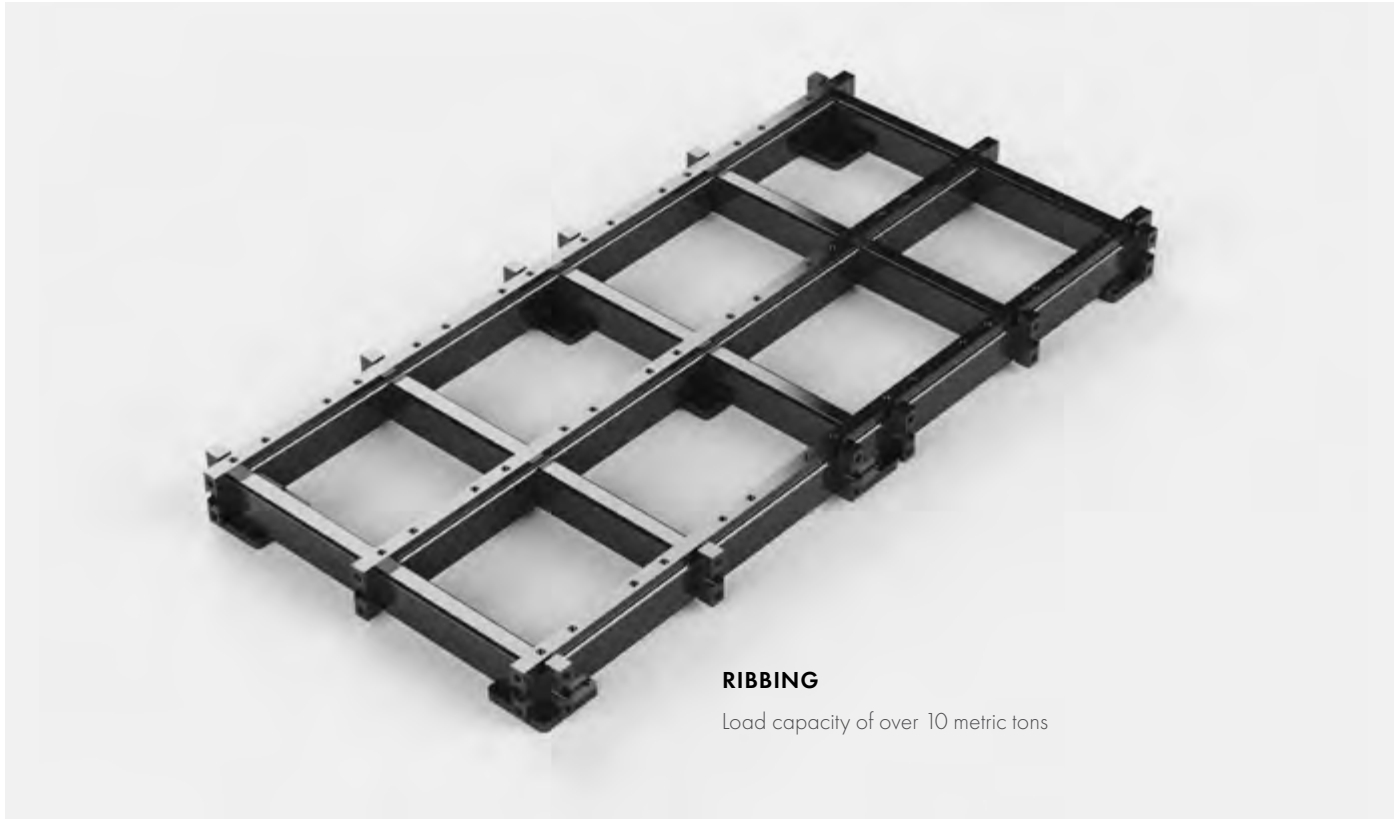

RIBBING

Load capacity of over 10 metric tons

STRONGER, MORE RIGID FRAME

The machined tubular frame construction of the PRO28 table provides improved flatness and torsional stiffness compared to plate only frames. The rigid frame with modular plates on the PRO28 means less high spots and less twisting compared to welded plate designs. The welded construction of a plate only design often leads to distortion and high spots around the corners and center.

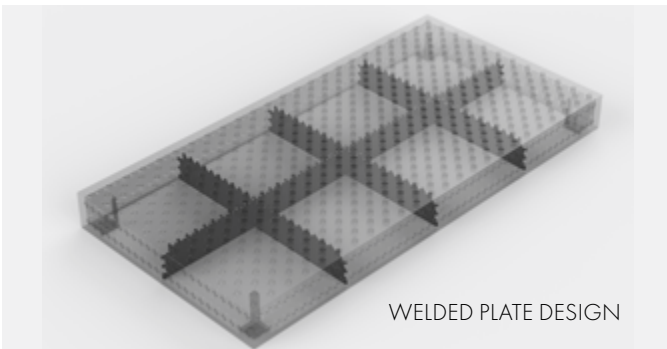

WELDED PLATE DESIGN

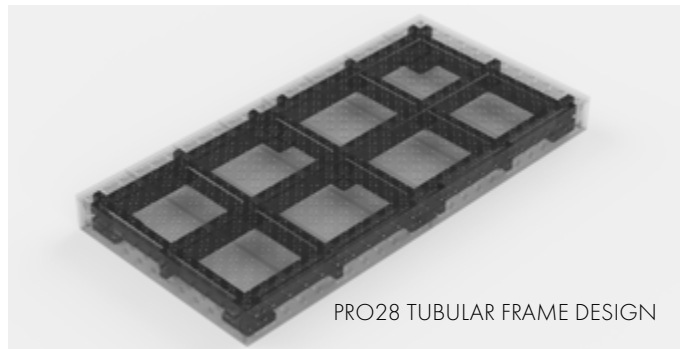

PRO28 TUBULAR FRAME DESIGN

1.2 X 1.2 FIVE FACE TABLE

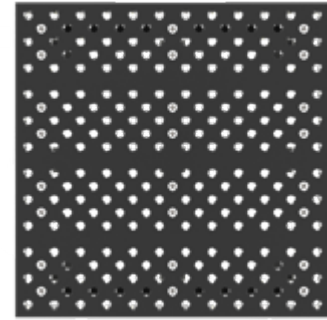
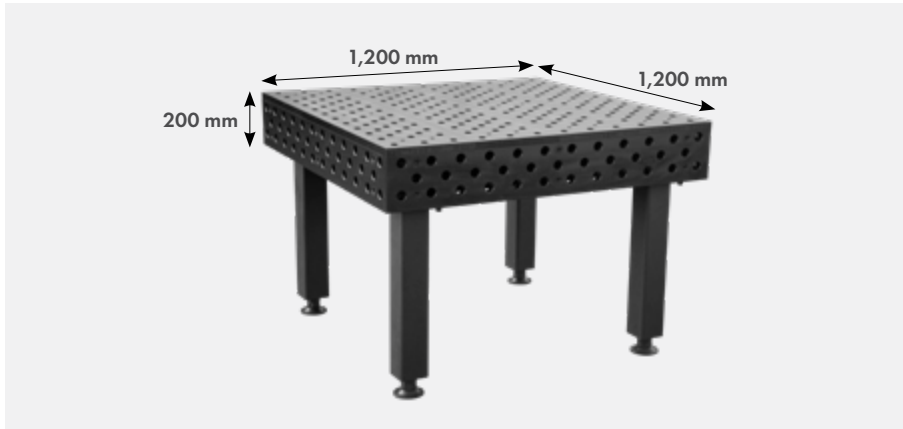

TOP VIEW



TABLETOP + FIXED LENGTH LEGS

PART NO.	INCLUDES LEG	TABLE SURFACE HEIGHT (MM)	CAPACITY (KG)	WEIGHT (KG)
T28-0121202-1004	T28-81004	600	4,000	746
T28-0121202-1005	T28-81005	700	4,000	750
T28-0121202-1007	T28-81007	850	4,000	756



TABLETOP + HEIGHT-ADJUSTABLE LEGS 550 ~ 900 mm

PART NO.	INCLUDES LEG	TABLE SURFACE HEIGHT (MM)	CAPACITY (KG)	WEIGHT (KG)
T28-0121202-2009	T28-82009	750 ~ 1,100	4,000	774



TABLETOP + FIXED LENGTH LEGS + CASTER AND LOCKING BRAKE 650 mm

PART NO.	INCLUDES LEG	TABLE SURFACE HEIGHT (MM)	CAPACITY (KG)	WEIGHT (KG)
T28-0121202-1406	T28-81406	850	3,200	766

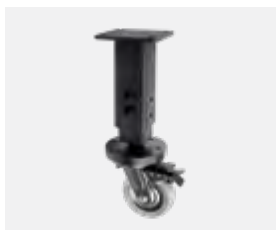

TABLETOP + HEIGHT-ADJUSTABLE LEGS + CASTER AND LOCKING BRAKE 550 ~ 750 mm

PART NO.	INCLUDES LEG	TABLE SURFACE HEIGHT (MM)	CAPACITY (KG)	WEIGHT (KG)
T28-0121202-2407	T28-82407	750 ~ 950	3,200	782

TABLETOP ONLY (no leg)

PART NO.	DIMENSION (MM)	WEIGHT (KG)
T28-0121202FP	1,200 x 1,200 x 200	700

2.1 X 1.0 FIVE FACE TABLE

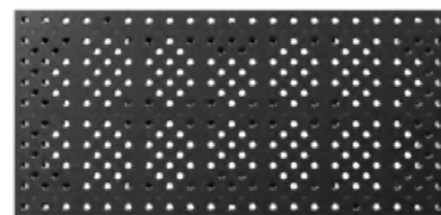
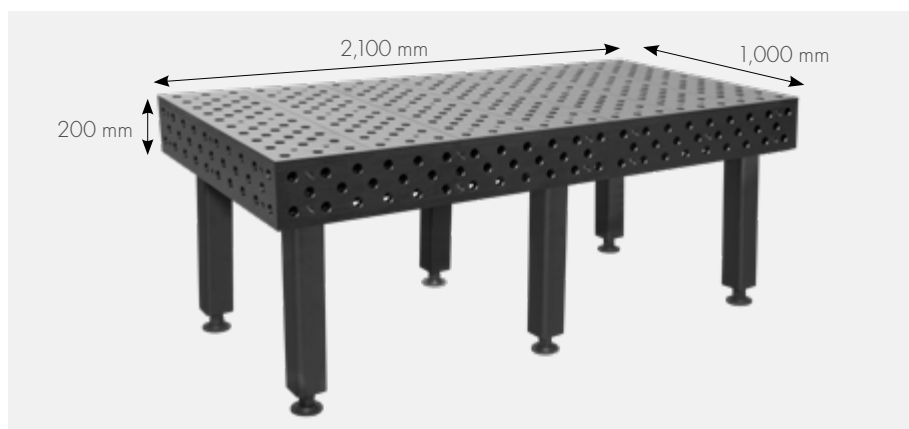

TOP VIEW



TABLETOP + FIXED LENGTH LEGS

PART NO.	INCLUDES LEG	TABLE SURFACE HEIGHT (MM)	CAPACITY (KG)	WEIGHT (KG)
T28-0211002-1004	T28-81004	600	6,000	1,019
T28-0211002-1005	T28-81005	700	6,000	1,025
T28-0211002-1007	T28-81007	850	6,000	1,034



TABLETOP + HEIGHT-ADJUSTABLE LEGS 550 ~ 900 mm

PART NO.	INCLUDES LEG	TABLE SURFACE HEIGHT (MM)	CAPACITY (KG)	WEIGHT (KG)
T28-0211002-2009	T28-82009	750 ~ 1,100	6,000	1,061



TABLETOP + FIXED LENGTH LEGS + CASTER AND LOCKING BRAKE 650 mm

PART NO.	INCLUDES LEG	TABLE SURFACE HEIGHT (MM)	CAPACITY (KG)	WEIGHT (KG)
T28-0211002-1406	T28-81406	850	4,800	1,049

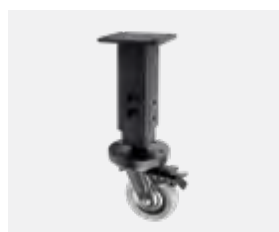

TABLETOP + HEIGHT-ADJUSTABLE LEGS + CASTER AND LOCKING BRAKE 550 ~ 750 mm

PART NO.	INCLUDES LEG	TABLE SURFACE HEIGHT (MM)	CAPACITY (KG)	WEIGHT (KG)
T28-0211002-2407	T28-82407	750 ~ 950	4,800	1,073

TABLETOP ONLY (no leg)

PART NO.	DIMENSION (MM)	WEIGHT (KG)
T28-0211002FP	2,100 x 1,000 x 200	950

2.4 X 1.2 FIVE FACE TABLE

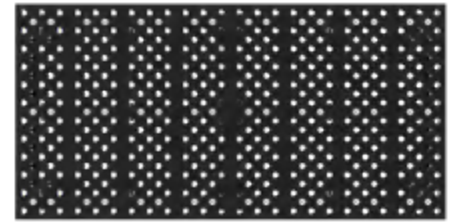
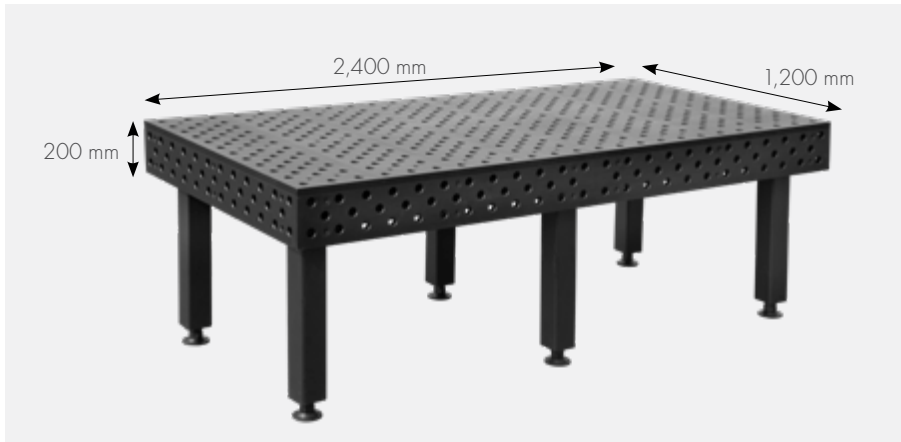

TOP VIEW



TABLETOP + FIXED LENGTH LEGS

PART NO.	INCLUDES LEG	TABLE SURFACE HEIGHT (MM)	CAPACITY (KG)	WEIGHT (KG)
T28-0241202-1004	T28-81004	600	6,000	1,199
T28-0241202-1005	T28-81005	700	6,000	1,205
T28-0241202-1007	T28-81007	850	6,000	1,214



TABLETOP + HEIGHT-ADJUSTABLE LEGS 550 ~ 900 mm

PART NO.	INCLUDES LEG	TABLE SURFACE HEIGHT (MM)	CAPACITY (KG)	WEIGHT (KG)
T28-0241202-2009	T28-82009	750 ~ 1,100	6,000	1,241



TABLETOP + FIXED LENGTH LEGS + CASTER AND LOCKING BRAKE 650 mm

PART NO.	INCLUDES LEG	TABLE SURFACE HEIGHT (MM)	CAPACITY (KG)	WEIGHT (KG)
T28-0241202-1406	T28-81406	850	4,800	1,229

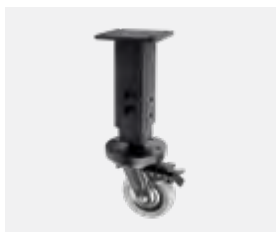

TABLETOP + HEIGHT-ADJUSTABLE LEGS + CASTER AND LOCKING BRAKE 550 ~ 750 mm

PART NO.	INCLUDES LEG	TABLE SURFACE HEIGHT (MM)	CAPACITY (KG)	WEIGHT (KG)
T28-0241202-2407	T28-82407	750 ~ 950	4,800	1,253

TABLETOP ONLY (no leg)

PART NO.	DIMENSION (MM)	WEIGHT (KG)
T28-0241202FP	2,400 x 1,200 x 200	1,130

PRO28 Welding Tables come with a wide range of mounting options to suit every workspace. Legs are ordered individually and the quantity required will vary depending on table size.

Legs mount onto plates at the bottom of the table; to calculate height of work surface add the height of the leg and the height of the table together. For example, the 650 mm Fix Length Leg combined with a table height of 200 mm results in a 850 mm high work surface. Leveling feet with spindles at the bottom of the legs offer fine adjustment and leveling.



T28-81004

T28-81005

T28-81007

T28-82009

T28-81406

T28-82407

PART NO.	DESCRIPTION	HEIGHT (MM)	SPINDLE ADJ. RANGE (MM)	STATIC LOAD CAPACITY (KG)	WEIGHT (KG)
T28-81004	400 mm H fixed length	400	50	2,000	11.5
T28-81005	500 mm H fixed length	500	50	2,000	12.5
T28-81007	650 mm H fixed length	650	50	2,000	14.0
T28-82009	Height-adjustable 550 - 900 mm	550 ~ 900	50	2,000	18.5
T28-81406	Leg with Caster and Locking Brake 650 mm	650	20	800	16.5
T28-82407	Height - adjustable with Caster and Locking Brake 550 - 750	550 ~ 750	20	800	20.5

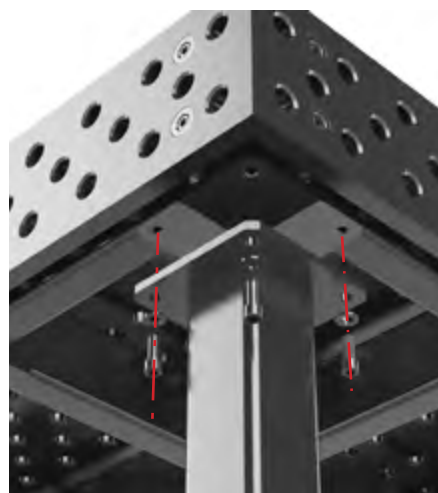

INSTALLATION TABLE LEGS:

Four M12 hex drive cap screws and washers are included with each leg.

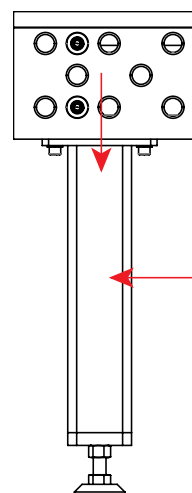

MAXIMUM SAFE BEARING LOAD:

Vertical force direction:
20 kN

Horizontal force direction:
2 kN

Maximum stability ensured by large section tube (100 x 100 mm).

LIFTING BRACKET

The Lifting Bracket with Eye Nut has a load bearing capacity of 1,800 kg and is used for transport of tables and other heavy components safely and easily. It is fastened quickly using 4 clamping bolts (T28-46450). Lateral forces should be avoided on the lifting bracket eye nut as this will decrease its load capacity.

With all lifting brackets users must observe general rules and regulations for material handling safety. Users must ensure Eye Nut or Hoist Rings are fully threaded and sit flat on the bearing surface. Users must ensure clamping bolts are fully seated onto the lifting bracket so that bolts can achieve full clamping capacity. Objects should not be lifted further than 100 mm off the ground and personnel are not allowed under objects being lifted or moved.

PART NO.	LENGTH (MM)	WIDTH (MM)	HEIGHT(KG)	WEIGHT (KG)
T28-97150	150	150	25	4.7



T28-97150

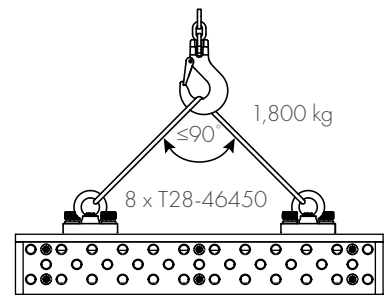
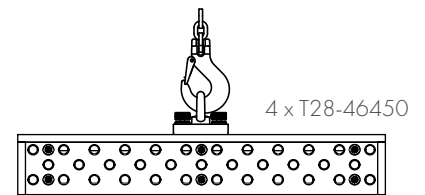

2 x 1,270 kg

TOOL CART

The wheeled Tool Carts keep your parts organized and nearby at all times. The Tool Cart can store numerous clamps, bolts, stops and squares on the top and front, while the back side stores up to 8x clamping squares up to 800 mm in height.

Comes with 2 fixed wheels and 2 swiveling castors.

PART NO.	LENGTH (MM)	WIDTH (MM)	HEIGHT(KG)	WEIGHT (KG)
T28-92910	640	1,070	1,110	102



STRAIGHT EDGE STOPS

Stops are used to align work pieces anywhere on the table. Slots provide adjustment while holes provide anchoring points for accessories such as clamps and V-Blocks.

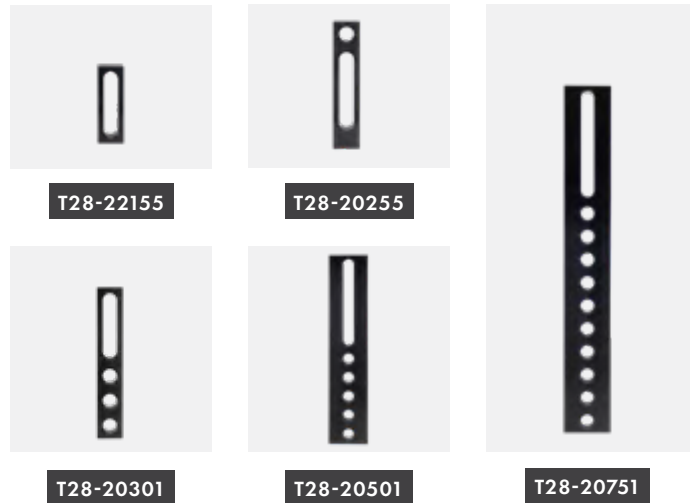

PART NO.	NAME	LENGTH (MM)	WIDTH (MM)	THICKNESS (MM)	SLOT LENGTH (MM)	WEIGHT (KG)
T28-22155	Straight Stop 150 SL	150	50	25	100	0.8
T28-20255	Straight Stop 225 SLH	225	50	25	100	1.4
T28-20301	Straight Stop 325 SLH	325	50	25	100	2.1
T28-20501	Straight Stop 500 W-SLH	500	100	25	200	7.9
T28-20751	Straight Stop 750 W-SLH	750	100	25	200	12.1

OTHER STOPS

Eccentric Stops provide infinite adjustment in a compact package. Item T28-27060 can also be used as a ground connection and features an M10 thread.

Flat Angles provide a broad adjustable stopping surface and an alternate, compact method of creating right angle fixtures.

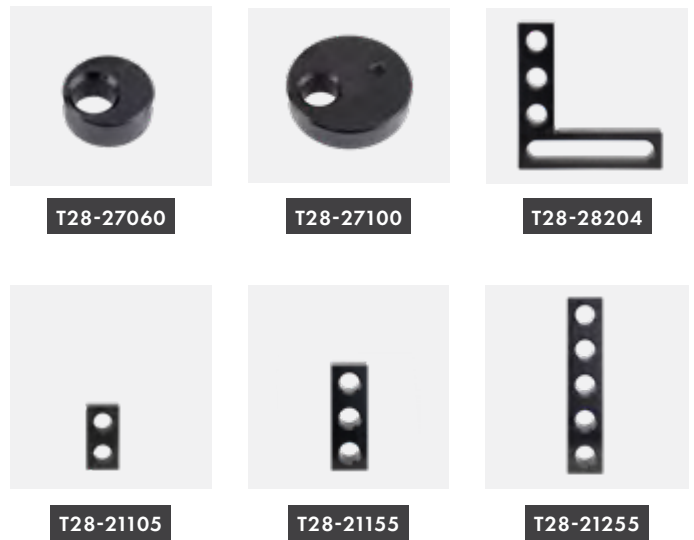

PART NO.	DESCRIPTION	LENGTH (MM)	WIDTH (MM)	THICKNESS (MM)	WEIGHT (KG)
T28-27060	Eccentric Stop, adjust range 19.5 ~ 39.5 mm	--	Ø: 60	25	0.4
T28-27100	Eccentric Stop, adjust range 24 ~ 74 mm	--	Ø: 100	25	1.4
T28-28204	Flat Angle 200 H - 200 SL	200	200	25	1.9
T28-21105	Straight Stop 100 H	100	50	25	0.8
T28-21155	Straight Stop 150 H	150	50	25	1.1
T28-21255	Straight Stop 250 H	250	50	25	1.8

ANGLE SQUARES

Angle Squares can be used in the same manner as a stop or combined with other elements to form more complex fixtures. Slots enable a range of adjustable options.



T28-24081



T28-23081



T28-23181



T28-23183



T28-24183



T28-25183



T28-23283.1



T28-12018

PART NO.	NAME	LENGTH (MM)	WIDTH (MM)	HEIGHT (MM)	THICKNESS (MM)	WEIGHT (KG)
T28-24081	Angle Square, 75 H - 75 H	75	50	75	25	1.0
T28-23081	Mounting Square, 75 W - 75W	75	150	75	25	2.9
T28-23181	Angle Square, 75 H - 175 SL	175	50	75	25	1.4
T28-23183	Angle Square, 175H - 175 SL	175	50	175	25	2.0
T28-24183	Angle Square, 175 H - 175 H	175	50	175	25	2.4
T28-25183	Angle Square, 175 SL - 175 SL	175	50	175	25	1.8
T28-23283.1	Angle Square, 175 H - 275 SL	275	50	175	25	2.5
T28-12018	Angle Square, 200 H - 175 SL	175	50	200	25	2.7

CAST ANGLE SQUARES

Cast Angle Squares are manufactured from high quality ductile cast iron. Their larger size and more robust construction allows them to stop larger parts and bear heavier loads when used as a table extension.



T28-23283



T28-13028L



T28-13028R

PART NO.	NAME	LENGTH (MM)	WIDTH (MM)	HEIGHT (MM)	THICKNESS (MM)	WEIGHT (KG)
T28-23283	Cast Angle Square 275 - L	175	50	275	25	6.0
T28-13028L T28-13028R	Heavy Duty Cast Square 300 - L/R	280	95	300	approx. 27	12.9

HEAVY DUTY CAST SQUARES

Heavy Duty Cast Squares are manufactured from high quality ductile cast iron and specifically designed to handle heavy parts.

They serve equally well for stopping large parts, serving as table extensions, or building vertically. Cut outs are optimized for lighter weight and easier handling.

Squares come in two versions with machined faces on either the left or right side.



T28-16038L



T28-16038R



T28-18038L



T28-18038R

PART NO.	NAME	LENGTH (MM)	WIDTH (MM)	HEIGHT (MM)	THICKNESS (MM)	WEIGHT (KG)
T28-16038L T28-16038R	HD Square 600, L/R	375	95	600	approx. 27	22.5
T28-18038L T28-18038R	HD Square 800, L/R	375	95	800	approx. 27	27.0

Slotted Square and Sliding Base provide heavy duty adjustment options for special applications.

The Sliding Base should be bolted to the table with a low profile clamping bolt, item T28-46350 to ensure proper clearance between the base and clamping square when sliding.



T28-15010



T28-93530

The Frame Square features bore holes on a 50 mm grid with slots. Two versions with stops on either left or right side.



T28-32103L



T28-32103R

PART NO.	DESCRIPTION	LENGTH (MM)	WIDTH (MM)	HEIGHT (MM)	WEIGHT (KG)
T28-15010	Slotted Adj. Square, C 500	500	100	100	16
T28-93530	Sliding Base	350	300	50	16
T28-32103L	Frame Square, 300, L	300	200	100	19.5
T28-32103R	Frame Square, 300, R	300	200	100	19.5

Extension Blocks are ideally suited as table extensions or for joining multiple tables together for long projects. Extension Blocks are hardened.

Only Extension Block T28-32202 has slots.

Extension Blocks 500 mm and longer in length have leg mounting holes, and all blocks over 500 mm in length should be supported by legs when used as a table extension.

Visit our product website for more information about mounting legs onto Extension Blocks.

SAFETY NOTE: Extension Blocks should only be joined to the table using connector bolts (Item T28-48250 or T28-48750). Do not use fast clamping bolts or other available bolts to join.



T28-32202



T28-32205



T28-32210



T28-32215

PART NO.	DESCRIPTION	LENGTH (MM)	WIDTH (MM)	HEIGHT (MM)	WEIGHT (KG)
T28-32202	Extension Block 200 x 200 x 200	200	200	200	32
T28-32205	Extension Block 500 x 200 x 200	500	200	200	68
T28-32210	Extension Block 1,000 x 200 x 200	1,000	200	200	130
T28-32215	Extension Block 1,500 x 200 x 200	1,500	200	200	190

BALL LOCK BOLTS

All bolts come in short and long versions.

Short bolts are designed for connecting two PRO28 components together such as a table to a stop or a stop to a square.

Long bolts are designed for connecting three PRO28 components together.



T28-46450



T28-46475



T28-47550



T28-47575



T28-47455



T28-46350



T28-46375



T28-46650



T28-46675

PART NO.	TYPE	LENGTH (MM)	DIA. (MM)	WEIGHT (KG)	NOTES
T28-46450	Fast Clamping Bolt, Short	95	28	0.5	Standard bolt for use when combining 2 components
T28-46475	Fast Clamping Bolt, Long	120	28	0.7	Standard bolt for use when combining 3 components
T28-47550	Universal bolt, Short	84	28	0.4	42 ~ 57 mm clamping range. For clamping 2 components
T28-47575	Universal bolt, Long	108	28	0.6	47 ~ 82 mm clamping range. For clamping 3 components
T28-47455	Universal bolt w/ collar, Short	106	28	0.6	45 ~ 53 mm clamping zone. For clamping 2 components
T28-46350	Flat Clamping Bolt, Short	74	28	0.4	Low profile bolt for use in oblong holes such as for sliding base plate
T28-46375	Fast Clamping Bolt, Flat, Long	99	28	0.5	For clamping 3 components
T28-46650	Flush Mounted Bolt, Short	67	28	0.3	Flush Mount head not suitable for placement in oblong slots
T28-46675	Flush Mount Bolt, Long	91	28	0.4	Flush Mount head not suitable for placement in oblong slots

CONNECTING BOLTS

The only bolt permitted for joining heavy parts such as Extension Blocks to tables.

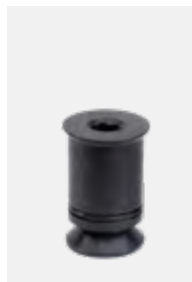

T28-48250



T28-48275



T28-48750

PART NO.	DESCRIPTION	LENGTH (MM)	DIA. (MM)	WEIGHT (KG)	NOTES
T28-48250	Flush Mount Connecting Bolt, Short	50	28	0.1	For connecting Extension Blocks or large squares to table side
T28-48275	Flush Mount Connecting Bolt, Long	75	28	0.2	For connecting Extension Blocks or large squares to table side
T28-48750	Connecting Bolt, Hex, Short	58	28	0.4	For connecting Extension Blocks or large squares to table side w/ slots

LOCATING PIN

Quick positioning bolt for applications where clamping force is not required.

PART NO.	LENGTH (MM)	DIA. (MM)	WEIGHT (KG)
T28-49550	70	28	0.4



T28-49550

MAGNETIC CLAMPING BOLT

Magnetic Clamping Bolt enables fast clamping for pressure-sensitive parts like thin sheet metal as well as enclosed shapes.

T28-94280 features cam action for easier release of parts.

PART NO.	LENGTH (MM)	DIA. (MM)	WEIGHT (KG)
T28-94270	68	34	0.09
T28-94280	96	36	0.2



T28-94270



T28-94280

CROSS POST BAR CLAMP

Versatile clamping systems ensure a clamp for your every need. All clamps easily set with one hand.

The Standard Screw Clamp adjusts by hand along the vertical and horizontal axis for precise placement anywhere on the table.

PART NO.	DESCRIPTION	VERTICAL BAR HEIGHT (MM)	HORIZONTAL BAR LENGTH (MM)	WEIGHT (KG)
T28-64230	Screw Clamp Standard	310	200, 40 ~ 165 Clamping Range	3.0



T28-64230

T-POST PIPE CLAMP

The T-Post Pipe Clamp features horizontal and vertical adjustment as well as pivoting action at the spindle head. An adjustment ring at the base allows it to sit in a lower profile during welding as the round bar sits below the table or clamping square surface.

For HORIZONTAL clamping, remove the top arm from the clamp post, and place directly into the tabletop holes.

PART NO.	DESCRIPTION	VERTICAL BAR HEIGHT (MM)	HORIZONTAL BAR LENGTH (MM)	WEIGHT (KG)
T28-61416	T-Post Pipe Clamp	250	110	2.4



T28-61416



HORIZONTAL CLAMPING

INSERTA CLAMPS

Place the Inserta Clamp into the 28 mm holes on the PRO28 Tabletop.

PART NO.	CLAMPING CAPACITY (MM)	THROAT DEPTH (MM)	CLAMPING PRESSURE (KG)	RAIL SIZE (MM)	WEIGHT (KG)
T28-63130T	300	120	460	22 x 11	1.5
T28-64130T	300	178	350	25 x 12	2.2



T28-63130T

INSERTA CLAMP W/ RATCHET HANDLE

The Ratchet Handle is ideal for tight space clamping, and the ratchet mechanism ensures rapid, vibration and torsion resistant clamping.

PART NO.	CLAMPING CAPACITY (MM)	THROAT DEPTH (MM)	CLAMPING PRESSURE (KG)	RAIL SIZE (MM)	WEIGHT (KG)
T28-63630	30 ~ 300	120	460	22 x 11	1.7



T28-63630

INSERTA PLIERS

Table Mount C-Clamp for repetitive clamping. Clamping range can be set with adjusting screw.



T28-60010



T28-60012

PART NO.	DESCRIPTION	CLAMPING LENGTH (MM)	CLAMPING RANGE (MM)	LENGTH (MM)	WIDTH (MM)	HEIGHT (MM)	DIA. (MM)	WEIGHT (KG)
T28-60010	Inserta Pliers 100	100	5 ~ 75	340	30	150	28	1.2
T28-60012	Inserta Pliers 160	160	0 ~ 75	360	30	150	28	1.2

RESTS

The Adjustable Rest is operated manually with a turn of the knurled band for minute height adjustment.

Insert into any fixturing hole on the PRO28 Welding Table for use as a support or rest for aligning stock at a uniform height and providing welding clearance. V-Blocks fit into the top cavity of the Adjustable Rests to support round pipes. Adjustable Rests are stackable for use with tall stock.

THREE MOUNTING OPTIONS:

- Insert into any hole on the PRO28 table with the Ø28 mm Locating Post.
- Securely fasten to the tabletop for repetitive applications using the Locking Pin with cap screw (included).
- Remove the Locating Post or the Locking Pin, and place the Rest anywhere on the PRO28 tabletop.



T28-540075



T28-540100



T28-551108

PART NO.	DESCRIPTION	TOP DIA. (MM)	TOP HEIGHT (MM)	WEIGHT (KG)
T28-540075	Fixed rest, 75	38	75	0.6
T28-540100	Fixed rest, 100	38	100	0.8
T28-551108	Adjustable rest, 75 ~ 110	80	75 ~ 110	2.5

CONE REST

Use the Cone Rest to locate and position round tubing horizontally or vertically through the centerline. The Setup Cone locates from within the tube ID [Max. 40 mm] at the tube ends, allowing for centerline location and positioning. Mount the Setup Cones on PRO28 Accessories using either of two interchangeable bases provided:

Horizontal clamping: Securely fasten to any 28 mm mounting hole on clamping accessories using the Locking Pin with cap screw.

Vertical clamping: Insert into any 28 mm mounting hole on clamping accessories or the tabletop, using the Locating Post.



T28-530040

PART NO.	HOLE MOUNT (MM)	DIA. (MM)	HEIGHT (MM)	MAX. TUBE SIZE (MM)	WEIGHT (KG)
T28-530040	28	42	38	40	0.4

BEND RESTS

The Bend Rest supports round stock at bends and elbows in fixturing, preventing lateral movement and providing clamp support.

The low profile design allows use of multiple Bend Rests as needed to elevate stock, leaving ample space for clamping.

Place Bend Rests directly into any hole on the PRO28 Tabletop, or use in combination with PRO28 Rests to set at desired height to meet clearance or alignment requirements for each unique fixture.

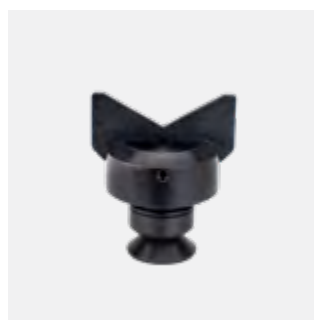

T28-520612



T28-520815

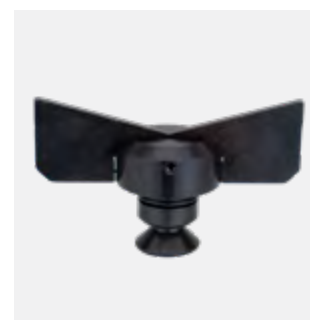

T28-521215

PART NO.	ANGLE	WIDTH (MM)	MAX. TUBE SIZE (MM)	WEIGHT (KG)
T28-520612	120°	60	80	0.3
T28-520815	150°	80	120 ~ 400	0.4
T28-521215	150°	120	120 ~ 400	0.5

V-BLOCKS

V-Blocks are used for holding round stock of different sizes.



T28-510612











T28-510815

























T28-511215





PART NO.	DESCRIPTION	HOLE MOUNT	HEIGHT (MM)	DIA. (MM)	V DEGREE	WEIGHT (KG)
T28-510612	V-Block Ø 60 120° with screwed-in collar	M16	42	60	120	0.6
T28-510815	V-Block Ø 80 150° with screwed-in collar	M16	35	80	150	1.0
T28-511215	V-Block Ø 120 150° with screwed-in collar	M16	35	120	150	1.7











Choose a fixture kit from below or contact us for consultation on a fixture kit to meet your specific needs.

KIT 100		PART NO. T28-90101		TOTAL: 38 PC		WEIGHT: 58 KG	
							
T28-64230	T28-61416	T28-60010	T28-510612	T28-46450	T28-22155		
4x	2x	2x	4x	12x	4x		
							
T28-20255	T28-23183	T28-23283					
4x	4x	2x					

KIT 200		PART NO. T28-90201		TOTAL: 70 PC		WEIGHT: 105 KG	
							
T28-64230	T28-61416	T28-60010	T28-510612	T28-46450	T28-94280		
8x	4x	2x	4x	24x	4x		
							
T28-22155	T28-20255	T28-23183	T28-23283				
8x	8x	4x	4x				

KIT 300		PART NO. T28-90301		TOTAL: 92 PC		WEIGHT: 199 KG	
							
T28-64230	T28-61416	T28-60010	T28-60012	T28-510612	T28-46450		
8x	4x	2x	2x	4x	36x		
							
T28-94280	T28-22155	T28-20255	T28-23183	T28-23283	T28-32103L + 32103R		
4x	8x	8x	8x	4x	1x + 1x		
							
T28-13028L + 13028R							
1x + 1x							

KIT 400		PART NO. T28-90401		TOTAL: 113 PC		WEIGHT: 350 KG	
							
T28-64230	T28-61416	T28-60010	T28-60012	T28-510612	T28-46450		
12x	8x	4x	2x	8x	36x		
							
T28-94280	T28-22155	T28-20255	T28-20501	T28-23183	T28-23283		
8x	8x	8x	4x	8x	2x		
							
T28-32103L + 32103R	T28-13028L + 13028R	T28-92910					
1x + 1x	1x + 1x	1x					

KIT 500		PART NO. T28-90501		TOTAL: 143 PC		WEIGHT: 492 KG	
							
T28-64230	T28-61416	T28-60010	T28-60012	T28-510612	T28-46450		
12x	8x	4x	2x	8x	48x		
							
T28-94280	T28-22155	T28-20255	T28-20501	T28-23183	T28-23283		
8x	12x	12x	4x	12x	4x		
							
T28-32103L + 32103R	T28-13028L + 13028R	T28-18038L + 18038R	T28-92910				
2x + 2x	1x + 1x	1x + 1x	1x				

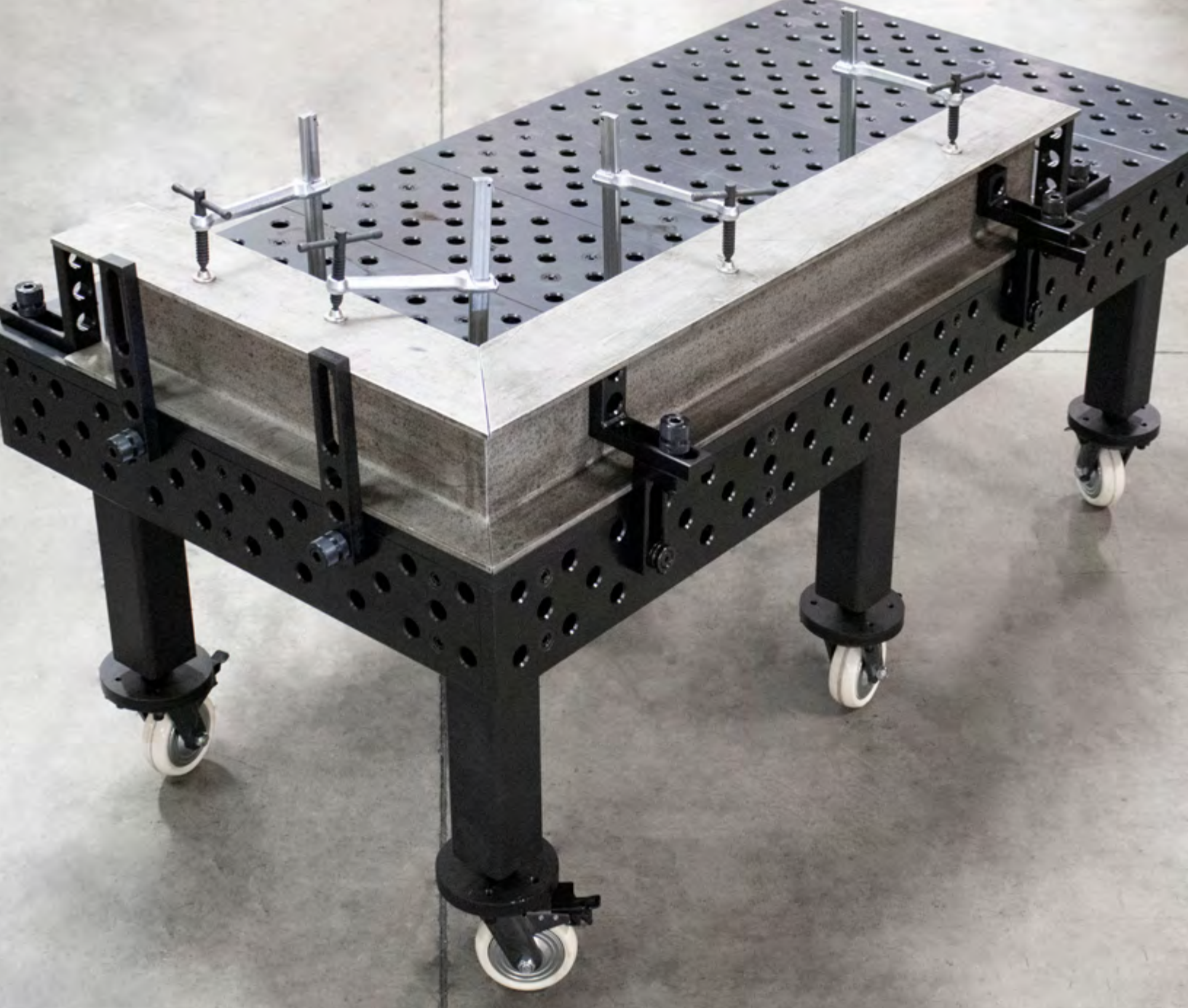

CONTACT US:

800.989.5244 / 1.562.949.8625

www.stronghandtools.com

sales@stronghandtools.com

Santa Fe Springs, CA 90670 U.S.A.

© 2020 Strong Hand Tools. All Rights Reserved.

